

1. Features

- Uses advanced SGT technology
- Extremely low $R_{DS(on)}$.typ=1.7m Ω @ $V_{GS}=10V$
- Excellent gate charge x $R_{DS(on)}$ product(FOM)

2. Application

- Motor control and drives
- Battery management
- DC/DC Converters
- General purpose applications

3. Pin configuration

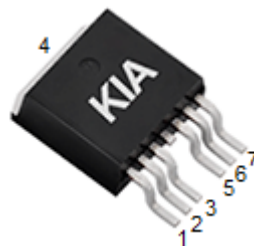

TO-263-6

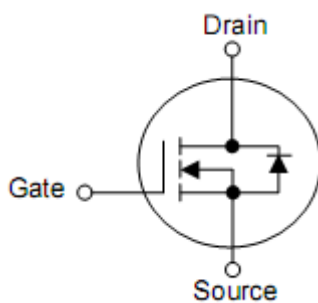

Pin	Function
1	Gate
4	Drain
2,3,5,6,7	Source

4. Ordering Information

Part Number	Package	Brand
KCC1808A	TO-263-6	KIA

5. Absolute maximum ratings

$T_C=25\text{ }^\circ\text{C}$ unless otherwise specified

Parameter	Symbol	Ratings	Unit
Drain-to-Source Voltage	V_{DS}	80	V
Continuous Drain Current	I_D	$T_C=25\text{ }^\circ\text{C}$ (Silicon limited)	270
		$T_C=25\text{ }^\circ\text{C}$ (Package limited)	200
		$T_C=100\text{ }^\circ\text{C}$ (Silicon limited)	170
Pulsed drain current ($T_C = 25\text{ }^\circ\text{C}$, t_p limited by T_{Jmax})	I_{DP}	750	A
Avalanche energy, single pulse ($L=0.5\text{mH}$, $R_g=25\Omega$)	E_{AS}	2500	mJ
Gate-Source voltage	V_{GS}	± 20	V
Power dissipation	P_{tot}	223	W
Junction & Storage Temperature Range	T_J & T_{STG}	-55 to 150	$^\circ\text{C}$

6. Thermal characteristics

Parameter	Symbol	Ratings	Units
Thermal resistance, Junction-case	$R_{\theta JC}$	0.54	$^\circ\text{C/W}$
Thermal resistance, junction-ambient	$R_{\theta JA}$	60	$^\circ\text{C/W}$

7. Electrical characteristics

(T_J=25°C, unless otherwise notes)

Parameter	Symbol	Test Condition	Value			Unit
			min.	typ.	max.	
Drain-source breakdown voltage	V _{(BR)DSS}	V _{GS} =0V, I _D =250μA	80	-	-	V
Gate threshold voltage	V _{GS(th)}	V _{DS} =V _{GS} , I _D =250μA, T _J =25°C	2	3	4	V
Zero gate voltage drain current	I _{DSS}	V _{DS} =80V, V _{GS} =0V, T _J =25°C	-	-	1	μA
		V _{DS} =64V, V _{GS} =0V, T _J =125°C	-	-	10	μA
Gate-source leakage current	I _{GSS}	V _{GS} =20V, V _{DS} =0V	-	-	100	nA
Drain-source on-state resistance	R _{DS(on)}	V _{GS} =10V, I _D =50A, T _J =25°C	-	1.7	2	mΩ
Transconductance	g _{fs}	V _{DS} =5V, I _D =40A	-	145	-	S
Input Capacitance	C _{iss}	V _{GS} =0V, V _{DS} =40V, f=1MHz	-	13621	-	pF
Output Capacitance	C _{oss}		-	2345	-	
Reverse Transfer Capacitance	C _{rss}		-	949	-	
Gate Total Charge	Q _G	V _{GS} =10V, V _{DS} =40V, I _D =50A	-	207	-	nC
Gate-Source charge	Q _{gs}		-	56	-	
Gate-Drain charge	Q _{gd}		-	42	-	
Turn-on delay time	t _{d(on)}	T _J =25°C, V _{GS} =10V, V _{DS} =40V, R _L =3Ω	-	36	-	ns
Rise time	t _r		-	130	-	
Turn-off delay time	t _{d(off)}		-	124	-	
Fall time	t _f		-	150	-	
Gate resistance	R _G	V _{GS} =0V, V _{DS} =0V, f=1MHz	-	1.85	-	Ω
Body Diode Forward Voltage	V _{SD}	V _{GS} =0V, I _{SD} =50A	-	0.85	1.2	V
Body Diode Reverse Recovery Time	t _{rr}	I _F =30A, dI/dt=500A/μs	-	112	-	ns
Body Diode Reverse Recovery Charge	Q _{rr}	I _F =30A, dI/dt=500A/μs	-	213	-	nC

8. Typical Characteristics

Figure 1. Typ. Output Characteristics ($T_j=25^\circ\text{C}$)

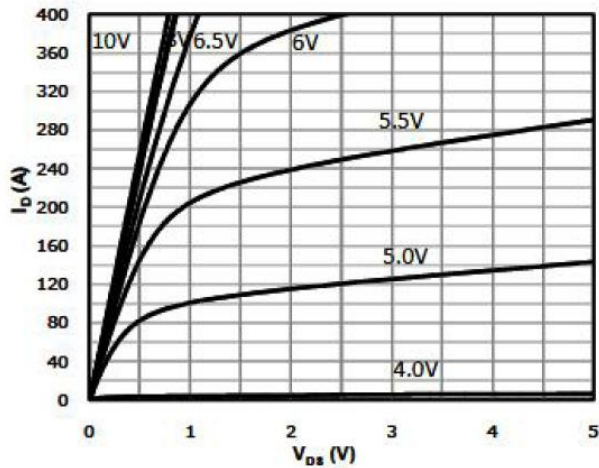

Figure 2. Transfer Characteristics (Junction Temperature)

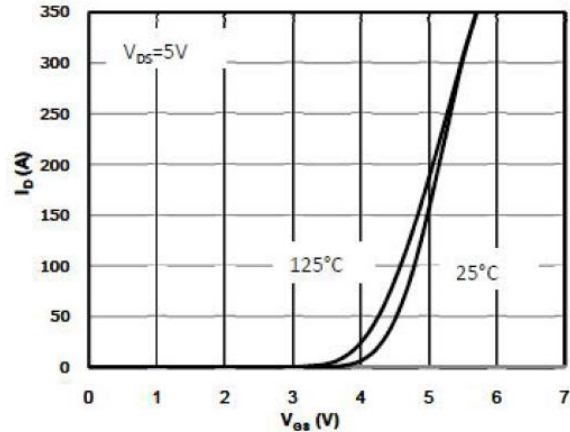

Figure 3. On-Resistance vs. Drain Current Junction and Gate Voltage Figure

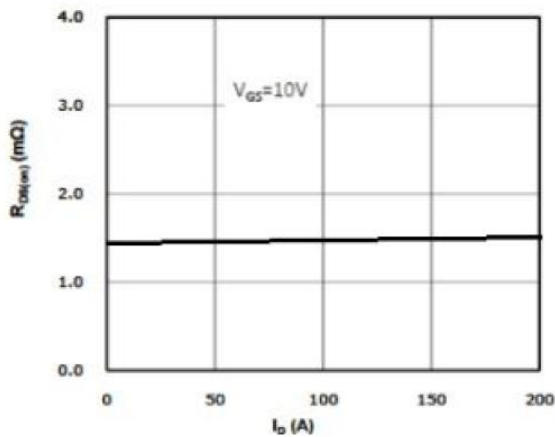

Figure 4. On-Resistance vs. Temperature

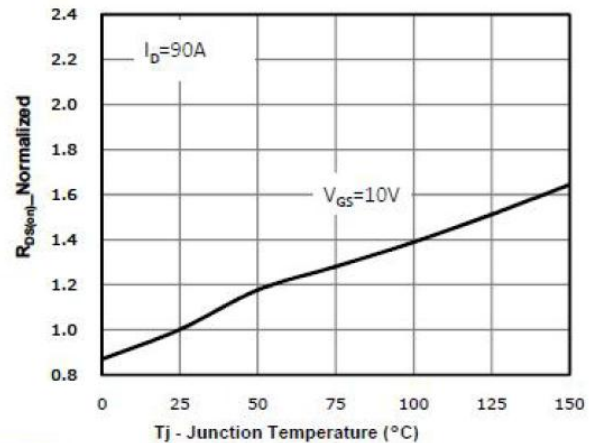

Figure 5. On-Resistance vs. Gate-Source Voltage (Junction Temperature)

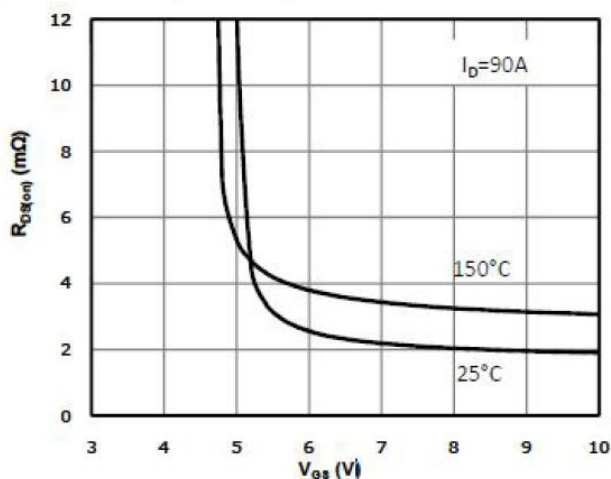

Figure 6. Body-Diode Characteristics (Junction Temperature)

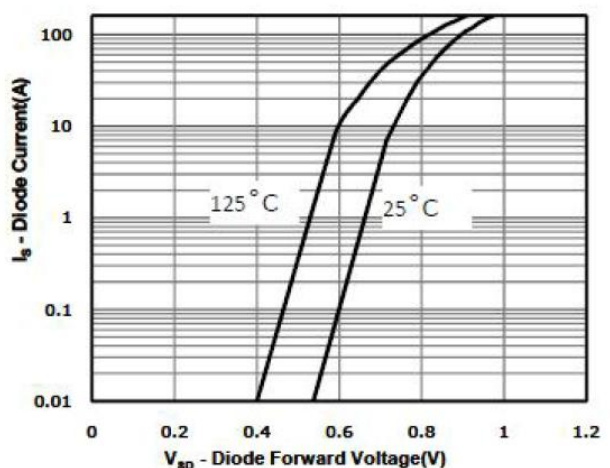

Figure 7. Gate-Charge Characteristics

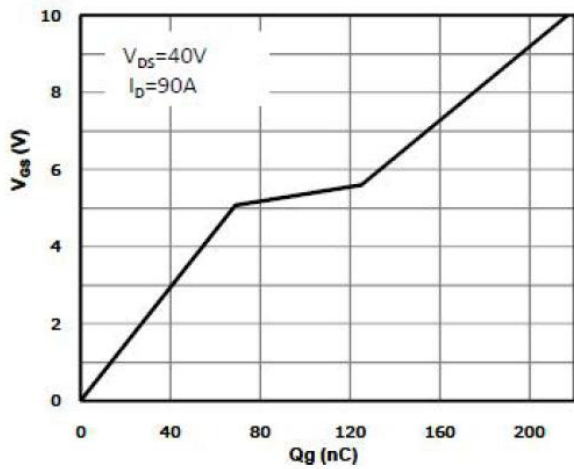

Figure 8. Drain Current Derating

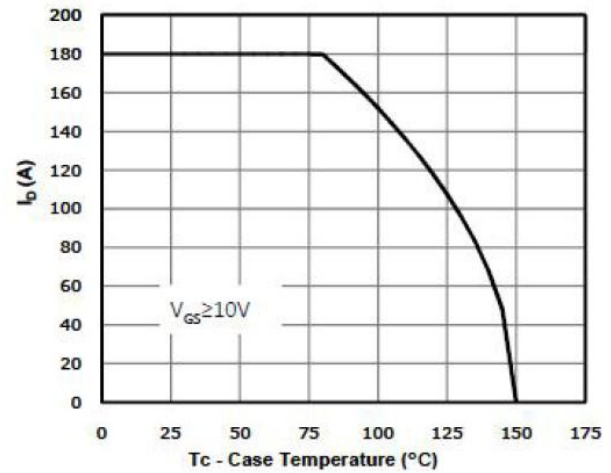

Figure 9. Capacitance Characteristics

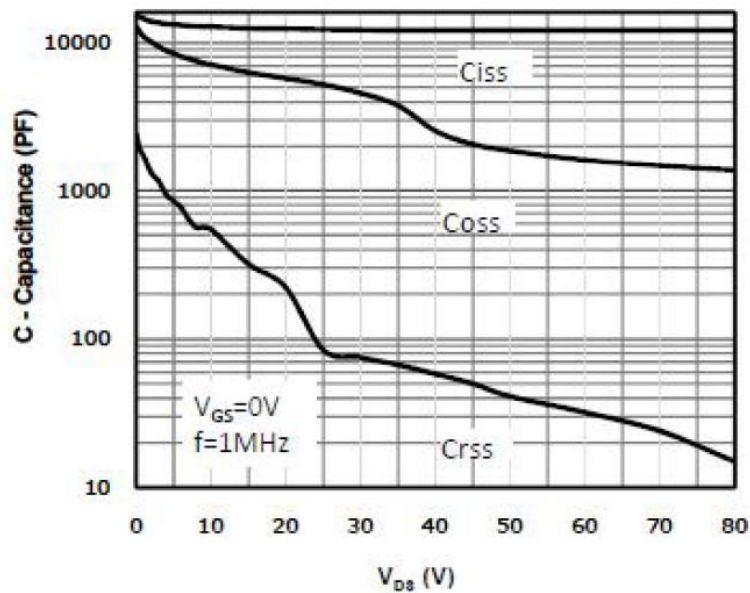
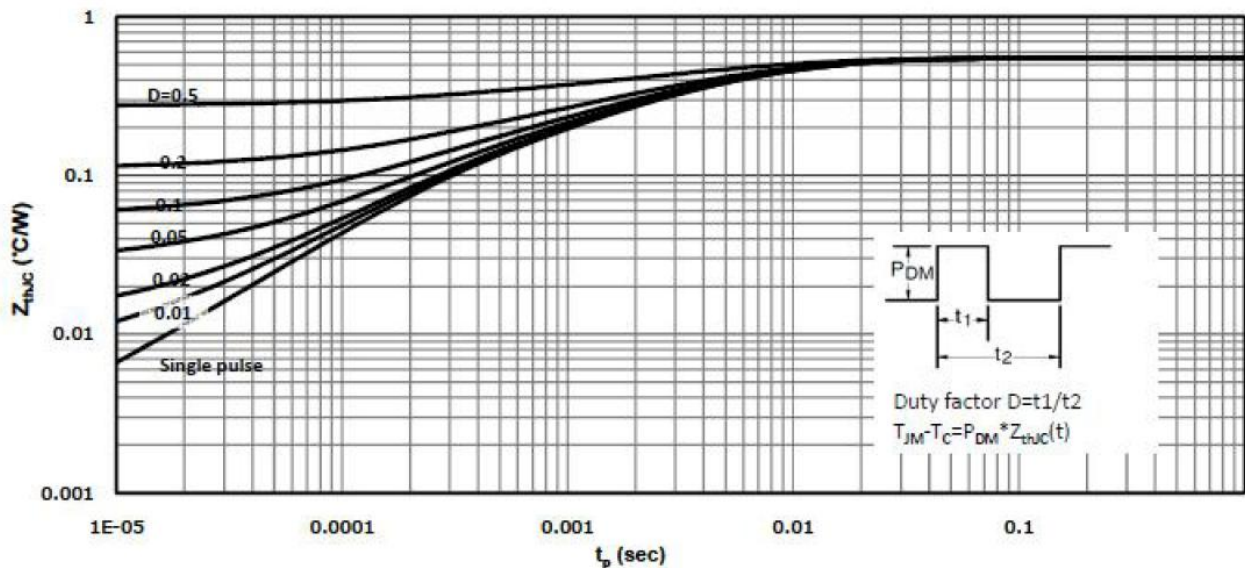
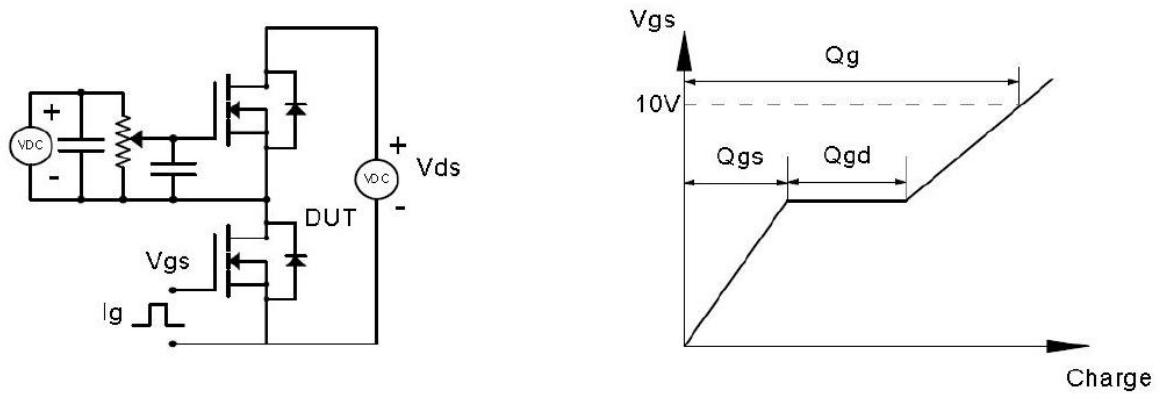

Figure 10. Normalized Maximum Transient Thermal Impedance (R_{thJC})



9. Test Circuit & Waveform

Gate Charge Test Circuit & Waveform



Resistive Switching Test Circuit & Waveforms

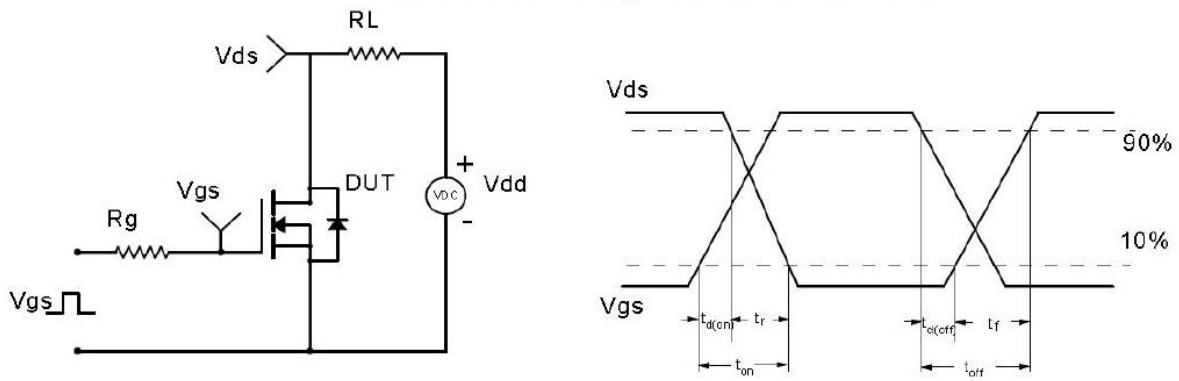

Unclamped Inductive Switching (UIS) Test Circuit & Waveforms

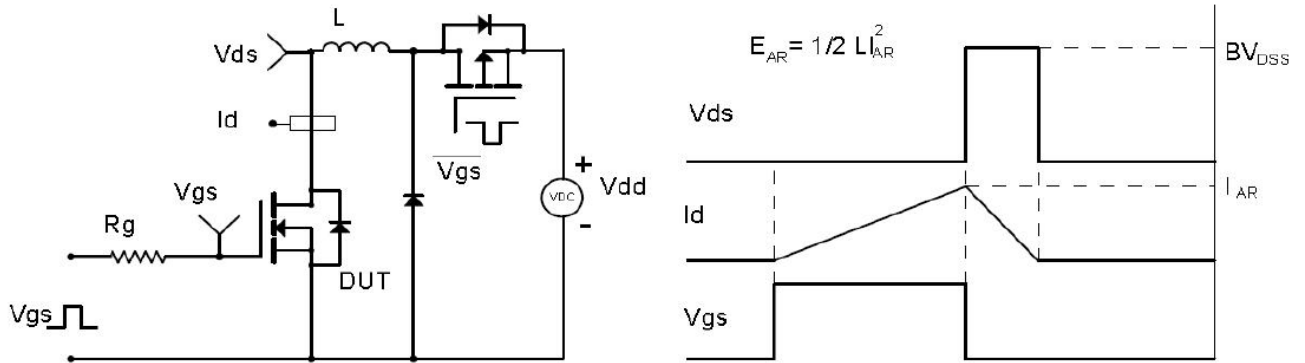

Diode Recovery Test Circuit & Waveforms

