

## 1. Description

KCX3406A is an N-channel enhancement mode power MOS field effect transistor which is produced using KIA's LVMOS technology. The improved process and cell structure have been especially tailored to minimize on-state resistance, provide superior switching performance.

This device is widely used in Secondary synchronous rectifier, Power Management for Inverter Systems.

## 2. Features

- 80A,60V, $R_{DS(ON)(typ.)}=8.5m\Omega @ V_{GS}=10V$
- SGT MOSFET
- Low Gate Charge
- Low Crss
- Fast switching
- Improved dv/dt capability

## 3. Pin configuration

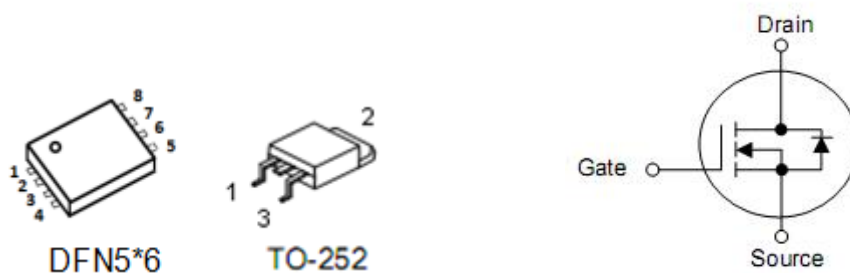

Pin		Function
DFN5*6	TO-252	
1,2,3	3	Source
4	1	Gate
5,6,7,8	2	Drain

#### 4. Ordering Information

Part Number	Package	Brand
KCY3406A	DFN5*6	KIA
KCD3406A	TO-252	KIA

#### 5. Absolute maximum ratings

$T_A=25^{\circ}\text{C}$  unless otherwise specified

Parameter	Symbol	Ratings	Unit	
Drain-to-Source Voltage	$V_{DSS}$	60	V	
Gate-to-Source Voltage	$V_{GSS}$	$\pm 20$	V	
Continuous Drain Current	$I_D$	$T_C=25^{\circ}\text{C}$	80	A
		$T_C=100^{\circ}\text{C}$	48	A
Pulsed Drain Current at $V_{GS}=10\text{V}$	$I_{DM}$	240	A	
Power Dissipation ( $T_C=25^{\circ}\text{C}$ )	$P_D$	63	W	
Derating Factor above $25^{\circ}\text{C}$		0.5	W/ $^{\circ}\text{C}$	
Single Pulsed Avalanche Energy <sup>1)</sup>	EAS	81	mJ	
Operation Junction Temperature Range	$T_J$	-55 to 150	$^{\circ}\text{C}$	
Storage Temperature Range	$T_{STG}$	-55 to 150	$^{\circ}\text{C}$	

#### 6. Thermal characteristics

Parameter	Symbol	Ratings	Unit
Thermal Resistance, Junction-to-Case	$R_{\theta JC}$	2.0	$^{\circ}\text{C/W}$
Thermal Resistance, Junction-to-Ambient	$R_{\theta JA}$	62	$^{\circ}\text{C/W}$

## 7. Electrical characteristics

(T<sub>J</sub>=25°C, unless otherwise notes)

Parameter	Symbol	Conditions	Min	Typ	Max	Units
Drain-to-Source Breakdown Voltage	BV <sub>DSS</sub>	V <sub>GS</sub> =0V, I <sub>D</sub> =250uA	60	--	--	V
Drain-to-Source Leakage Current	I <sub>DSS</sub>	V <sub>DS</sub> =60V, V <sub>GS</sub> =0V	--	--	1	uA
Gate-to-Source Leakage Current	I <sub>GSS</sub>	V <sub>GS</sub> =±20V, V <sub>DS</sub> =0V	--	--	±100	nA
Gate Threshold Voltage	V <sub>GS(TH)</sub>	V <sub>DS</sub> =V <sub>GS</sub> , I <sub>D</sub> =250uA	1.0	2.0	3.0	V
Static Drain-to-Source On-Resistance	R <sub>DS(ON)</sub>	V <sub>GS</sub> =10V, I <sub>D</sub> =13.5A	--	8.5	9.5	mΩ
		V <sub>GS</sub> =4.5V, I <sub>D</sub> =11.5A	--	13	15	mΩ
Gate Resistance	R <sub>G</sub>	F=1MHz	--	1.8	--	Ω
Input Capacitance	C <sub>iss</sub>	F=1.0MHz, V <sub>GS</sub> =0V, V <sub>DS</sub> =30V	--	1065	--	pF
Output Capacitance	C <sub>oss</sub>		--	430	--	pF
Reverse Transfer Capacitance	C <sub>rss</sub>		--	22	--	pF
Turn-on Delay Time	t <sub>d(ON)</sub>	V <sub>DD</sub> =30V, V <sub>GS</sub> =10V, R <sub>G</sub> =3Ω, I <sub>D</sub> =13.5A <sup>2), 3)</sup>	--	8	--	nS
Rise Time	t <sub>rise</sub>		--	54	--	nS
Turn-Off Delay Time	t <sub>d(OFF)</sub>		--	19	--	nS
Fall Time	t <sub>fall</sub>		--	8.8	--	nS
Total Gate Charge	Q <sub>g</sub>	V <sub>DD</sub> =48V, V <sub>GS</sub> =10V, I <sub>D</sub> =13.5A <sup>2), 3)</sup>	--	16.8	--	nC
Gate-to-Source Charge	Q <sub>gs</sub>		--	5.9	--	nC
Gate-to-Drain (Miller) Charge	Q <sub>gd</sub>		--	2.7	--	nC
Continuous Source Current	I <sub>SD</sub>	Integral Reverse P-N Junction Diode in the MOSFET	--	--	80	A
Pulsed Source Current	I <sub>SM</sub>		--	--	240	A
Diode Forward Voltage	V <sub>SD</sub>	I <sub>S</sub> =13.5A, V <sub>GS</sub> =0V	--	--	1.4	V
Reverse Recovery Time	t <sub>rr</sub>	I <sub>S</sub> =13.5A, V <sub>GS</sub> =0V, dI <sub>F</sub> /dt=100A/us <sup>2)</sup>	--	52	--	ns
Reverse Recovery Charge	Q <sub>rr</sub>		--	0.05	--	nC

Notes:

- 1.L=0.5mH, V<sub>DD</sub>=50V, R<sub>G</sub>=10Ω, starting T<sub>J</sub>=25°C ;
- 2.Pulse Test : Pulse width≤300us, Duty cycle≤2% ;
- 3.Essentially independent of operating temperature.

**8. Typical Characteristics**

Figure 1. Output Characteristics

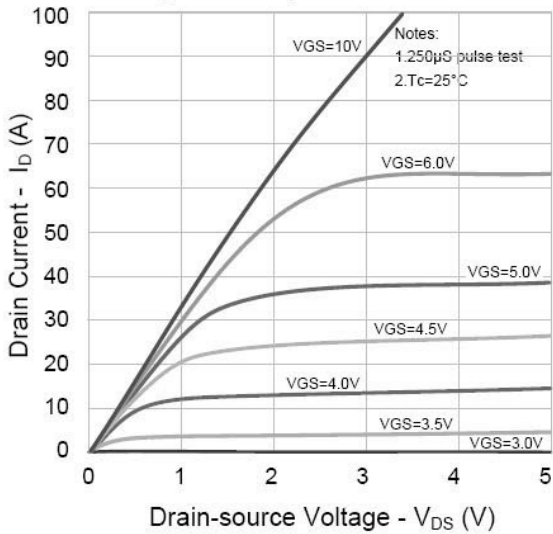

Figure 2. Transfer Characteristics

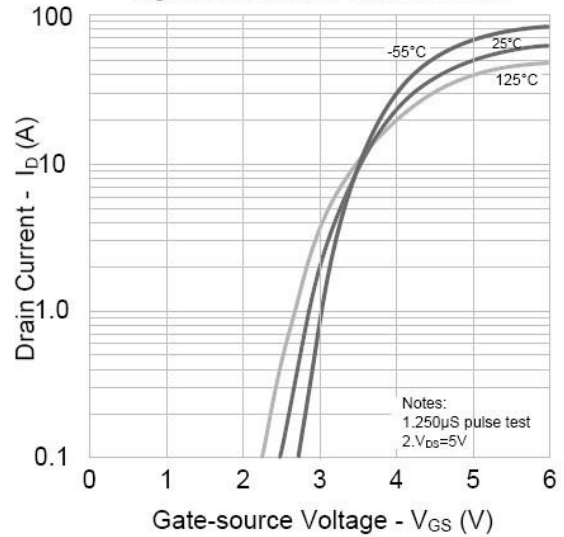

Figure 3. On-resistance vs. Drain Current

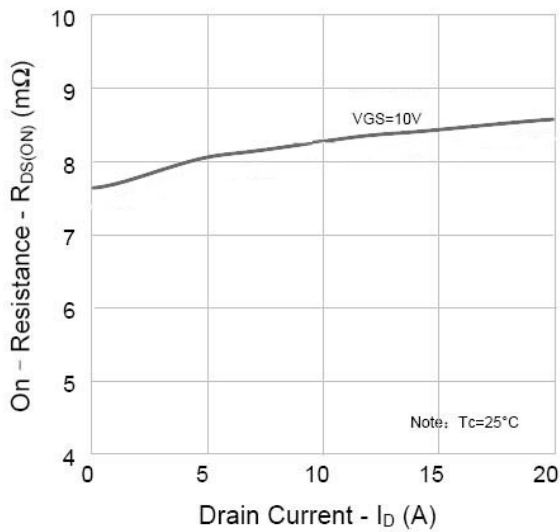

Figure 4. Body Diode Forward Voltage Variation vs. Source Current and Temperature

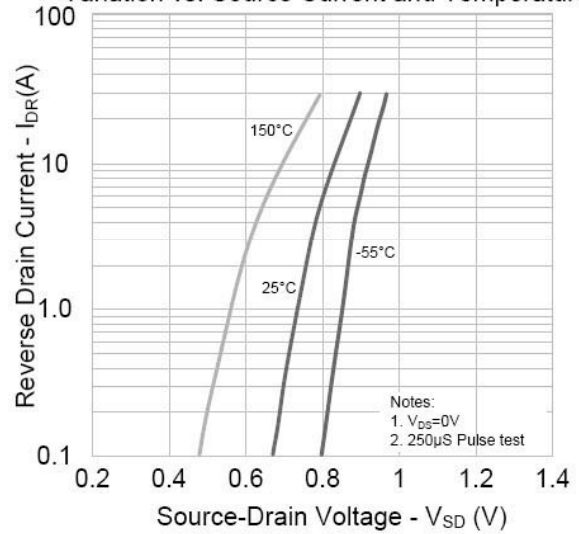

Figure 5. Capacitance Characteristics

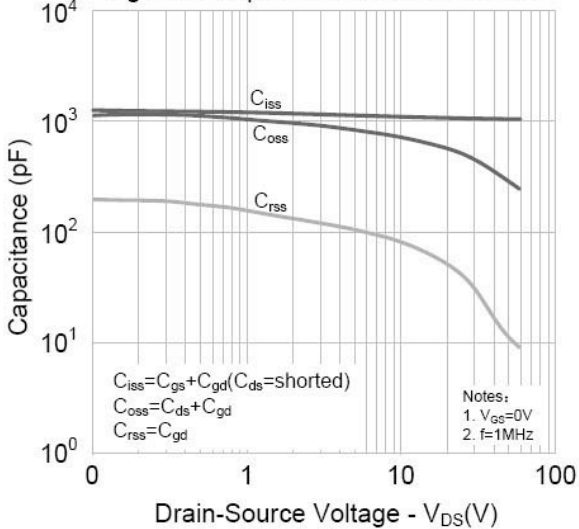

Figure 6. Gate Charge

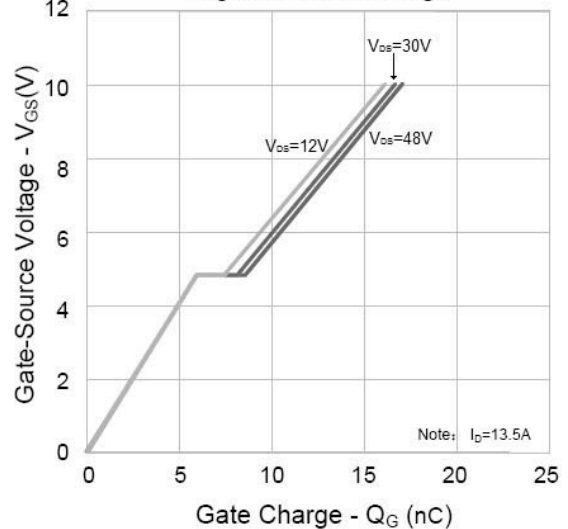

Figure 7. Breakdown Voltage vs. Temperature Characteristics

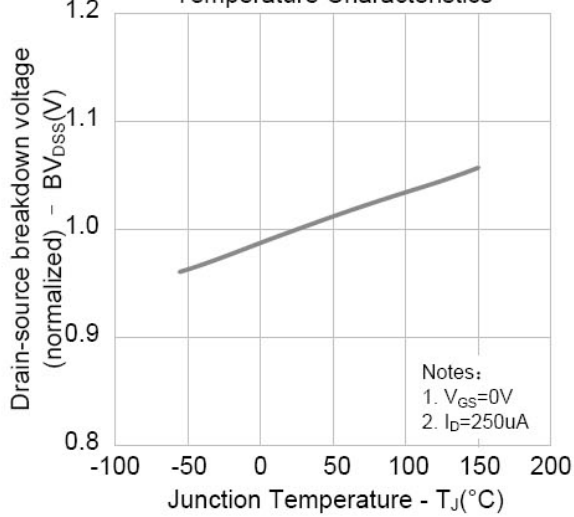

Figure 8. On-resistance vs. Temperature Characteristics

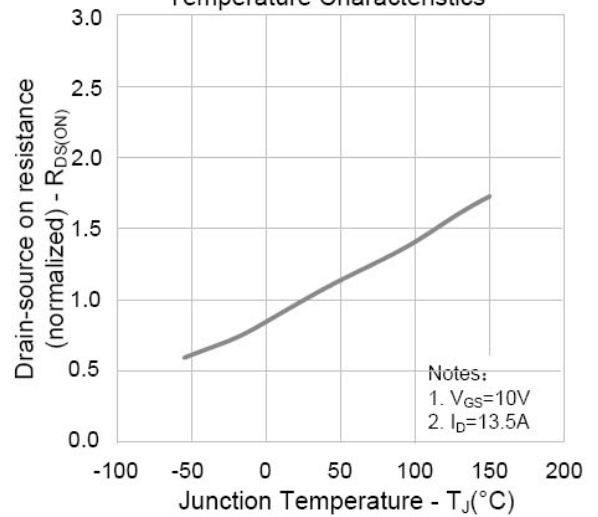

Figure 9-1. Max. Safe Operating Area (SVG069R5ND/MJ)

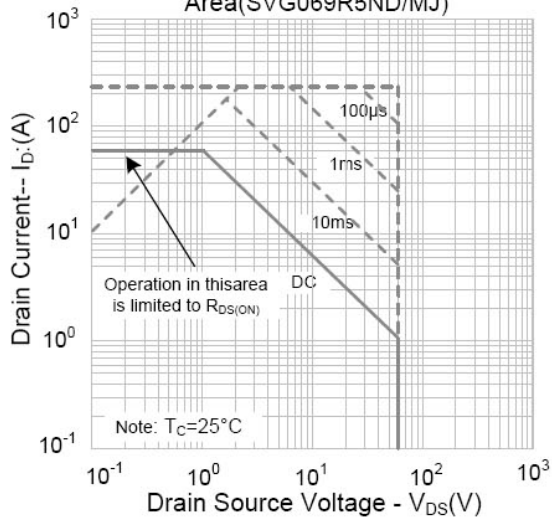
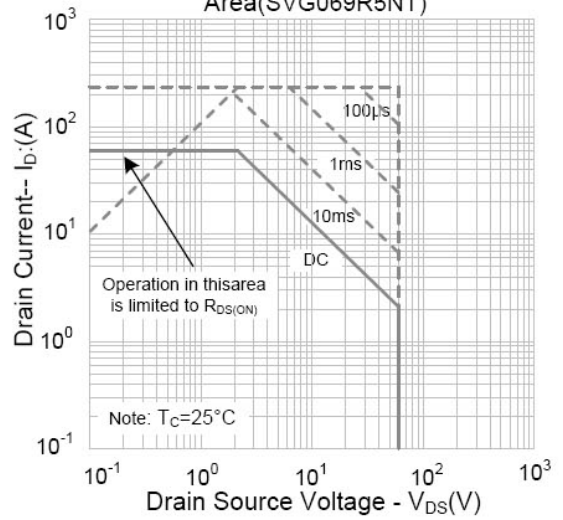
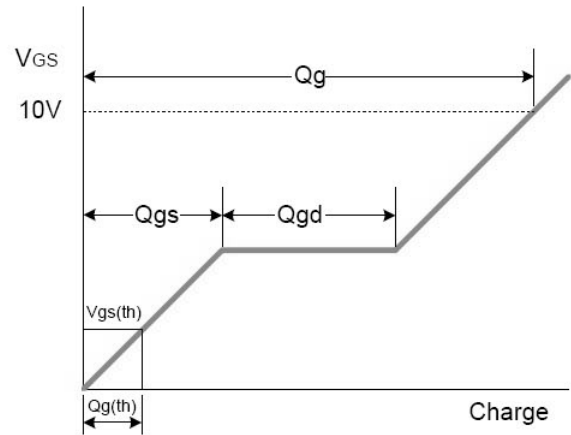
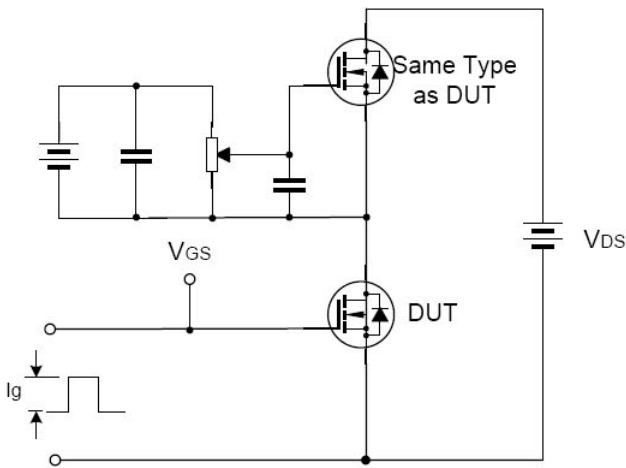

Figure 9-2. Max. Safe Operating Area (SVG069R5NT)



**9. Test Circuits and Waveforms**

**Gate Charge Test Circuit & Waveform**



**Resistive Switching Test Circuit & Waveform**

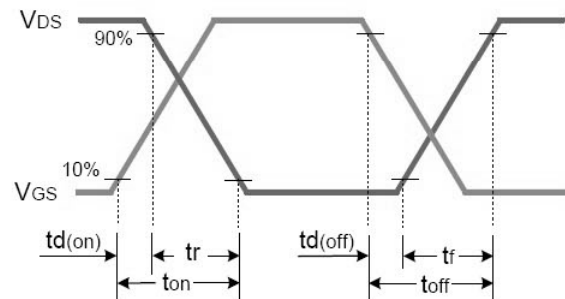
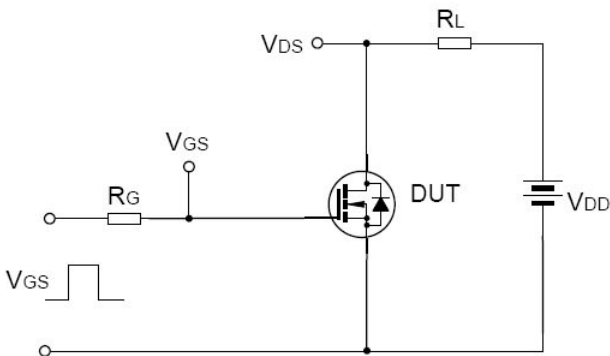

**Unclamped Inductive Switching Test Circuit & Waveform**

