

1. General Features

- n RoHS Compliant
- n $R_{DS(ON),typ.}=0.8\Omega@V_{GS}=10V$
- n Low Gate Charge Minimize Switching Loss
- n Fast Recovery Body Diode

2. Applications

- n Adaptor
- n Charger
- n SMPS Standby Power

3. Pin configuration

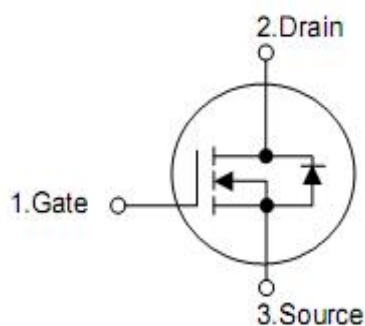
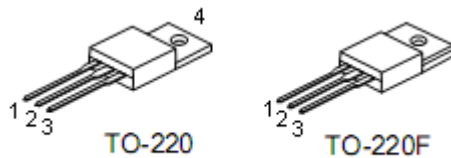

Pin	Function
1	Gate
2	Drain
3	Source
4	Drain

4. Ordering Information

Part Number	Package	Brand
KNP4540A	TO-220	KIA
KNF4540A	TO-220F	KIA

5. Absolute maximum ratings

(T_c= 25 °C , unless otherwise specified)

Symbol	Parameter	KNP4540A	KNF4540A	Unit
V _{DSS}	Drain-to-Source Voltage	400		V
V _{GSS}	Gate-to-Source Voltage	±30		
I _D	Continuous Drain Current	6.0		A
I _{DM}	Pulsed Drain Current at V _{GS} =10V	24		
E _{AS}	Single Pulse Avalanche Energy	200		mJ
P _D	Power Dissipation	75	25	W
	Derating Factor above 25 °C	0.6	0.2	W/ °C
T _L T _{PAK}	Maximum Temperature for Soldering Leads at 0.063in (1.6mm) from Case for 10 seconds, Package Body for 10 seconds	300 260		°C
T _J &T _{STG}	Operating and Storage Temperature Range	-55 to 150		

Caution: Stresses greater than those listed in the “Absolute Maximum Ratings” may cause permanent damage to the device.

6. Thermal characteristics

Symbol	Parameter	KNP4540A	KNF4540A	Unit
R _{θJC}	Thermal Resistance, Junction-to-Case	1.67	5.0	°C /W
R _{θJA}	Thermal Resistance, Junction-to-Ambient	62	100	

6. Electrical characteristics

OFF Characteristics		(T _J =25°C, unless otherwise specified)				
Symbol	Parameter	Test Conditions	Min.	Typ.	Max.	Unit
B _V DSS	Drain-to-Source Breakdown Voltage	V _{GS} =0V, I _D =250uA	400	--	--	V
I _{DSS}	Drain-to-Source Leakage Current	V _{DS} =400V, V _{GS} =0V	--	--	1	uA
		V _{DS} =320V, V _{GS} =0V, T _J =125°C	--	--	100	
I _{GSS}	Gate-to-Source Leakage Current	V _{GS} =+20V, V _{DS} =0V	--	--	+1.0	uA
		V _{GS} =-20V, V _{DS} =0V	--	--	-1.0	
ON Characteristics		(T _J =25°C, unless otherwise specified)				
Symbol	Parameter	Test Conditions	Min.	Typ.	Max.	Unit
R _{DS(ON)}	Static Drain-to-Source On-Resistance	V _{GS} =10V, I _D =3.0A	--	0.8	1.0	Ω
V _{GS(TH)}	Gate Threshold Voltage	V _{DS} =V _{GS} , I _D =250uA	2.0	--	4.0	V
g _{FS}	Forward Transconductance	V _{DS} =15V, I _D =3A	--	5.0	--	S
Dynamic Characteristics		Essentially independent of operating temperature				
Symbol	Parameter	Test Conditions	Min.	Typ.	Max.	Unit
C _{iss}	Input Capacitance	V _{GS} =0V, V _{DS} =25V, f=1.0MHZ	--	490	--	pF
C _{rss}	Reverse Transfer Capacitance		--	7.5	--	
C _{oss}	Output Capacitance		--	63	--	
Q _g	Total Gate Charge	V _{DD} =200V, I _D =6A, V _{GS} =0 to 10V	--	14	--	nC
Q _{gs}	Gate-to-Source Charge		--	3.1	--	
Q _{gd}	Gate-to-Drain (Miller) Charge		--	6.4	--	
Resistive Switching Characteristics		Essentially independent of operating temperature				
Symbol	Parameter	Test Conditions	Min.	Typ.	Max.	Unit
t _{d(ON)}	Turn-on Delay Time	V _{DD} =200V, I _D =6A, V _{GS} = 10V, R _G =9.1Ω	--	8.1	--	nS
t _{rise}	Rise Time		--	10.2	--	
t _{d(OFF)}	Turn-Off Delay Time		--	26	--	
t _{fall}	Fall Time		--	14	--	
Source-Drain Body Diode Characteristics		(T _J =25°C, unless otherwise specified)				
Symbol	Parameter	Test Conditions	Min	Typ.	Max.	Unit
I _{SD}	Continuous Source Current ^[2]	Integral PN-diode in MOSFET	--	--	6.0	A
I _{SM}	Pulsed Source Current ^[2]		--	--	24	
V _{SD}	Diode Forward Voltage	I _S =30A, V _{GS} =0V	--	--	1.5	V
t _{rr}	Reverse recovery time	V _{GS} =0V, I _F =6A, diF/dt=100A/μs	--	305	--	ns
Q _{rr}	Reverse recovery charge		--	840	--	uC

Note:

1. T_J=+25°C to +150°C

2. Pulse width ≤ 380μs; duty cycle ≤ 2%.

7. Test circuits and waveforms

Figure 1. Maximum Forward Bias Safe Operating Area

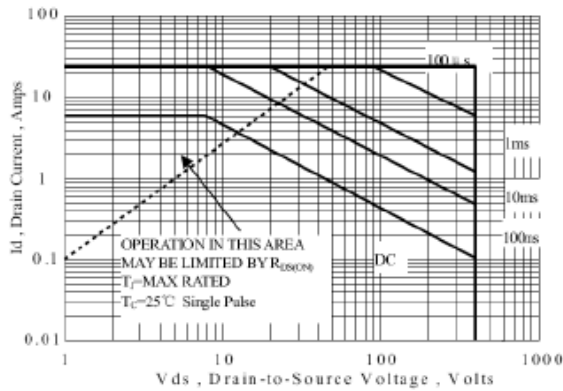

Figure 2. Maximum Power Dissipation vs Case Temperature

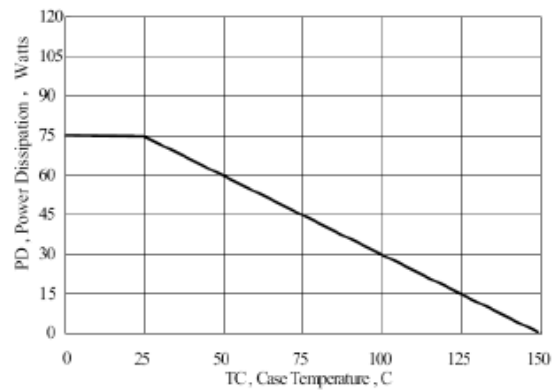

Figure 3. Maximum Continuous Drain Current vs Case Temperature

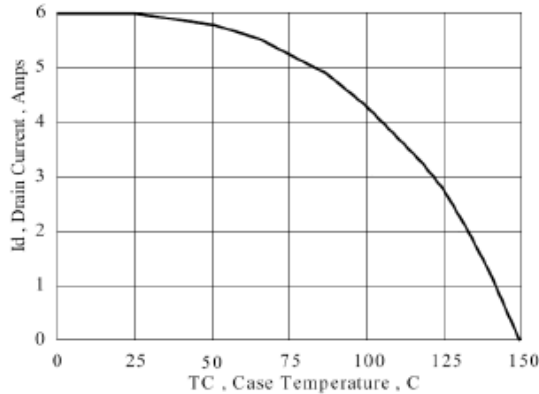

Figure 4. Typical Output Characteristics

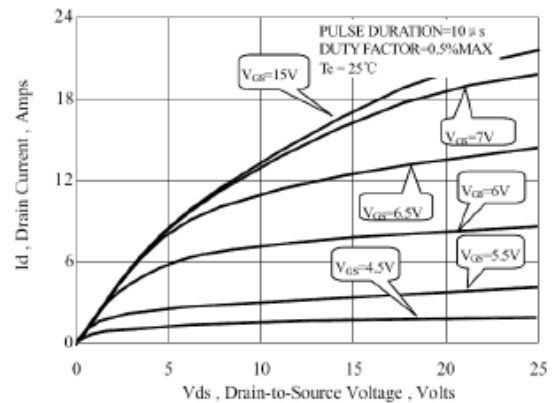

Figure 5. Maximum Effective Thermal Impedance, Junction to Case

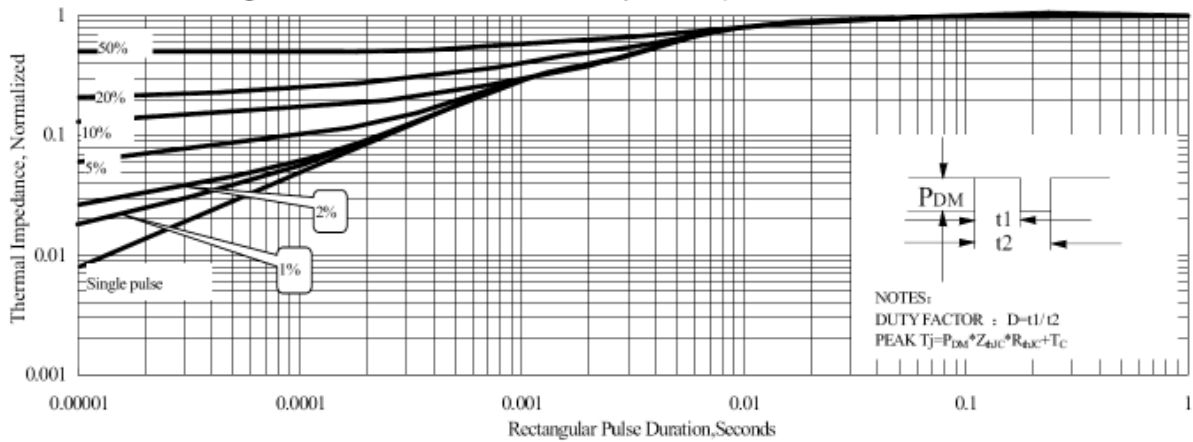

Figure 6. Maximum Peak Current Capability

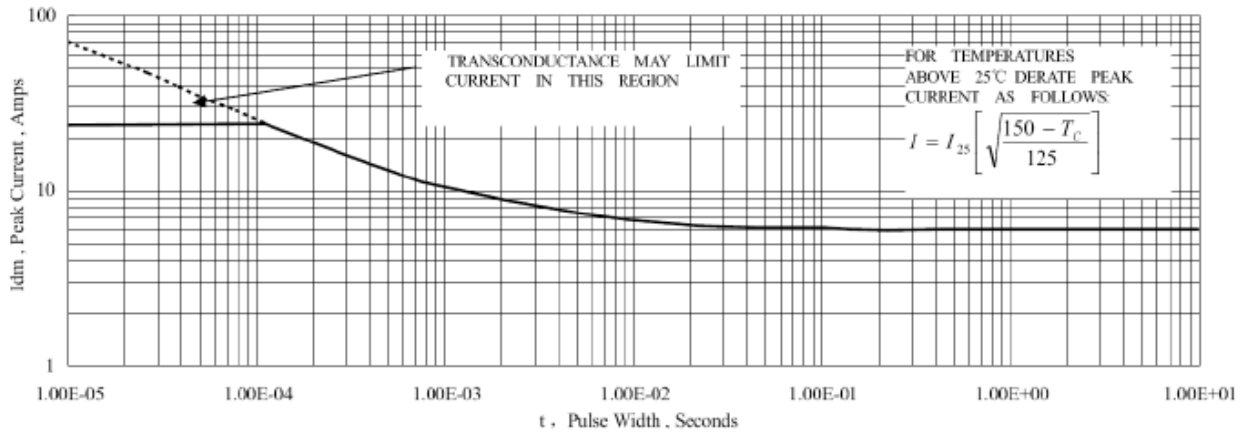

Figure 7. Typical Transfer Characteristics

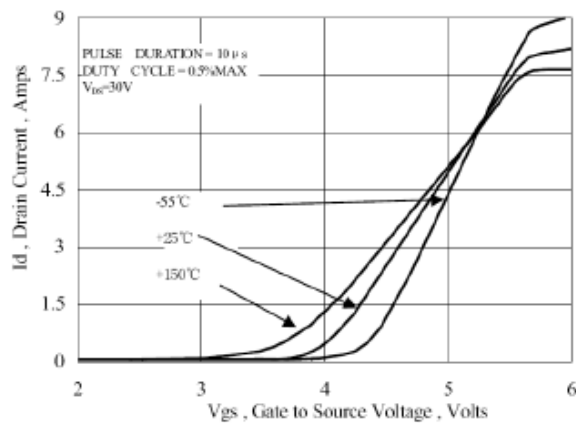

Figure 8. Typical Drain to Source ON Resistance vs Gate Voltage and Drain Current

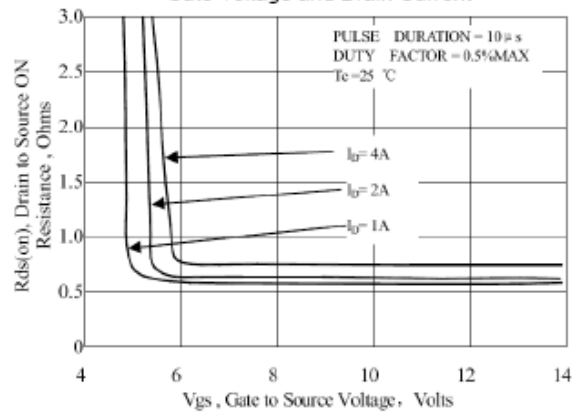

Figure 9. Typical Drain to Source ON Resistance vs Drain Current

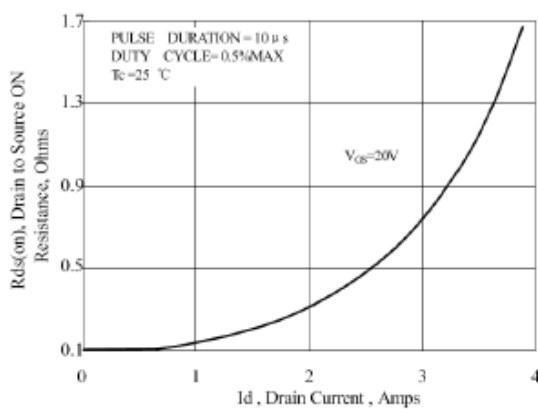

Figure 10. Typical Drain to Source on Resistance vs Junction Temperature

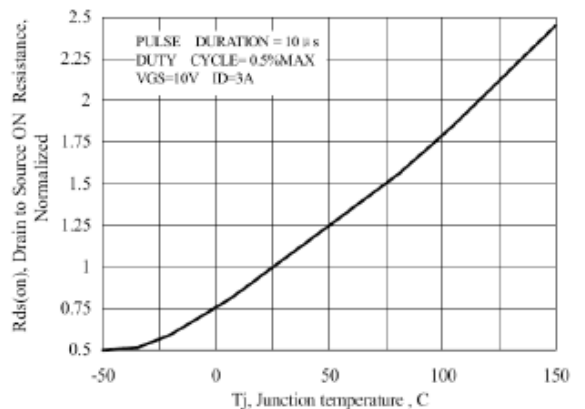

Figure 11. Typical Threshold Voltage vs Junction Temperature

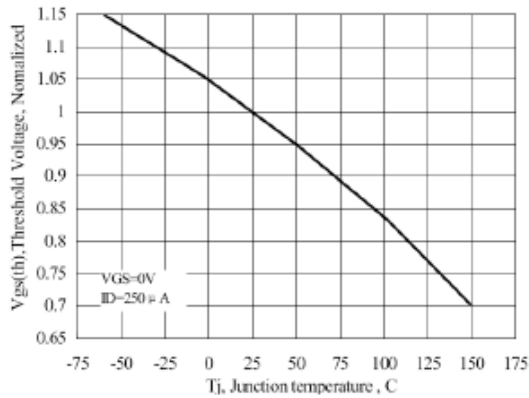

Figure 1.2 Typical Breakdown Voltage vs Junction Temperature

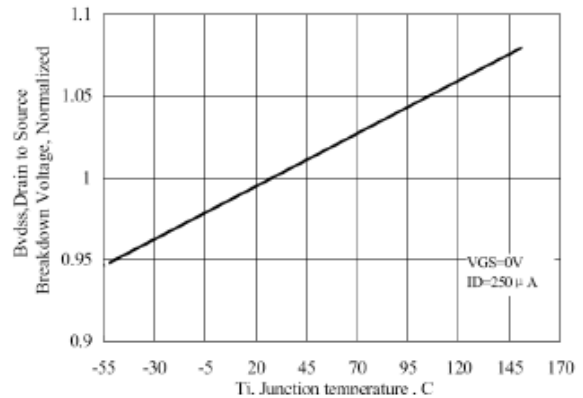

Figure 13. Typical Capacitance vs Drain to Source Voltage

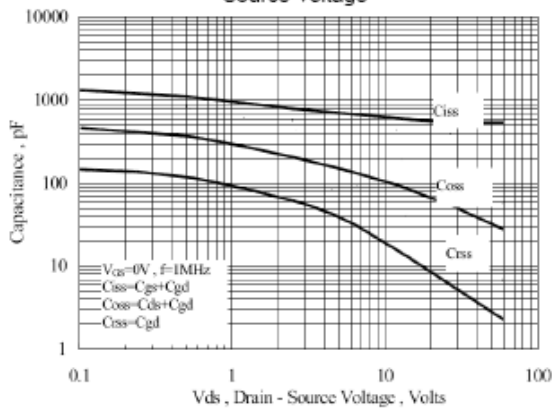

Figure 14. Typical Gate Charge vs Gate to Source Voltage

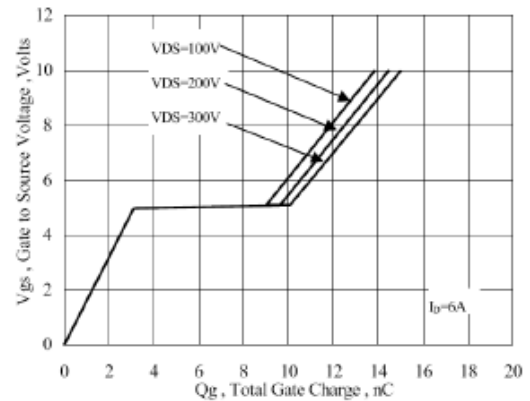

Figure 15. Typical Body Diode Transfer Characteristics

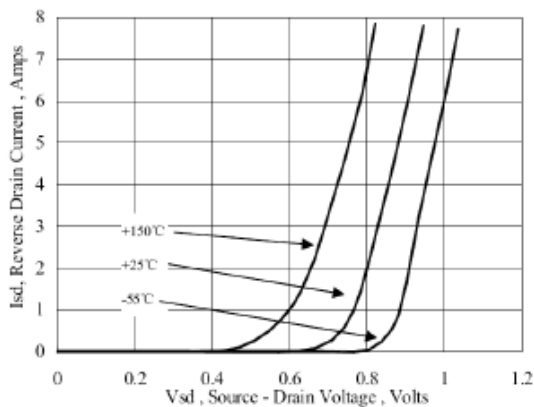
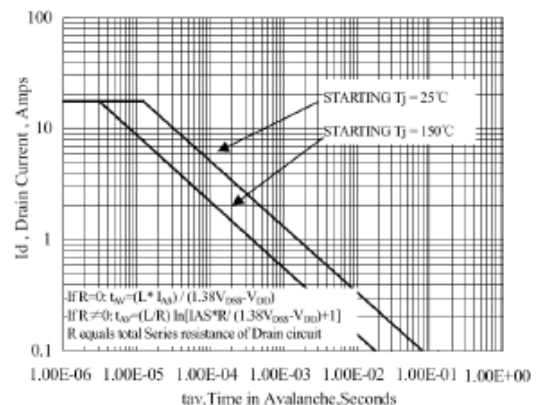

Figure 16. Unclamped Inductive Switching Capability



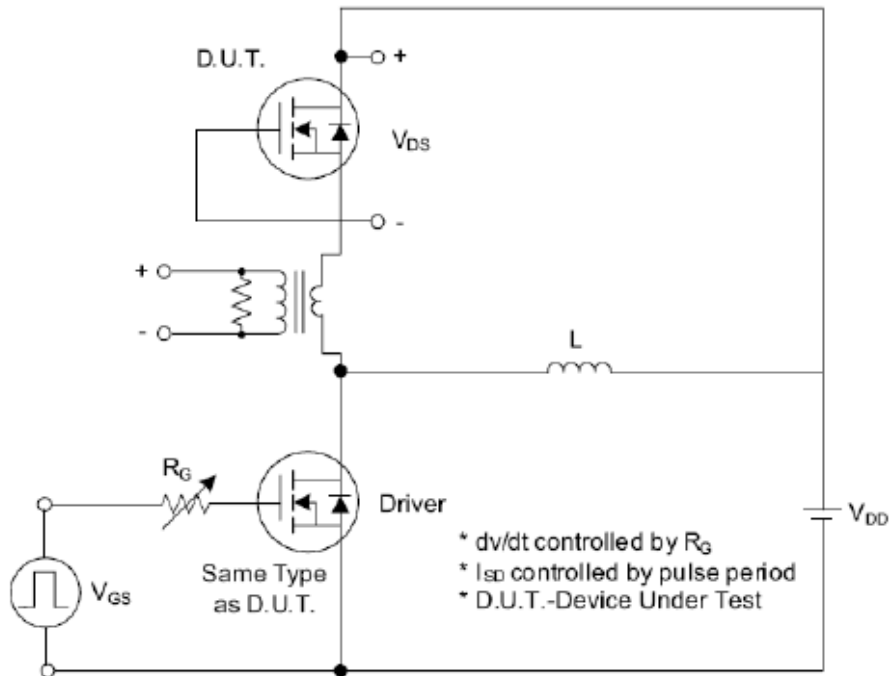

Fig. 1.1 Peak Diode Recovery dv/dt Test Circuit

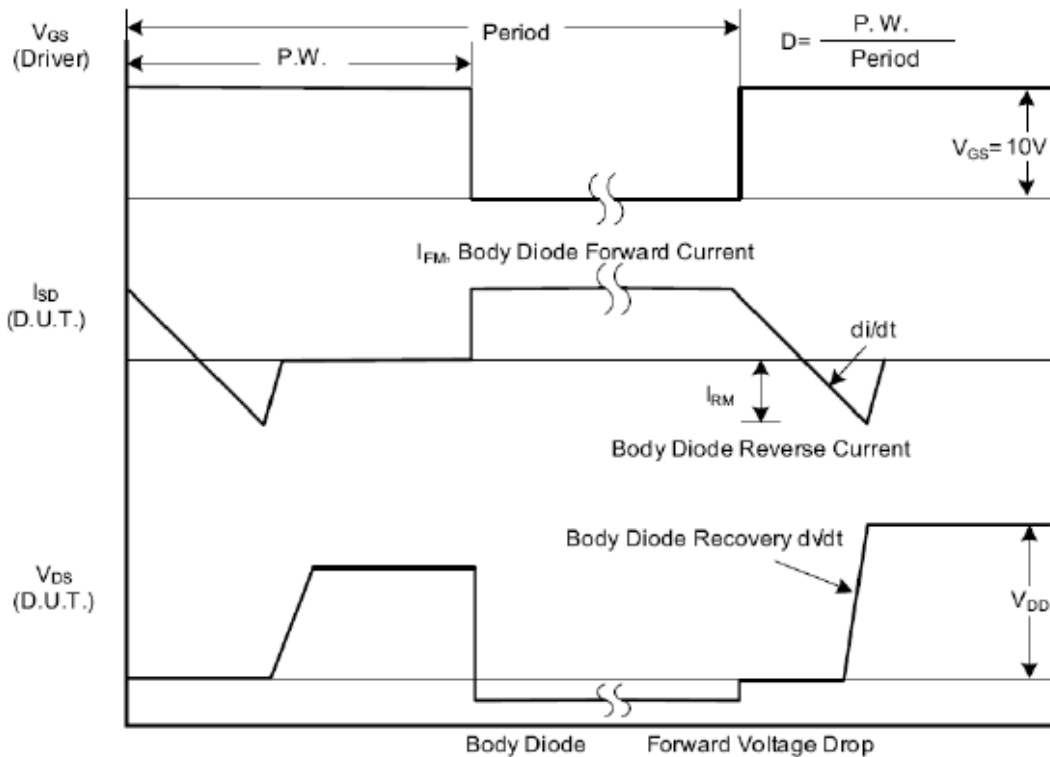

Fig. 1.2 Peak Diode Recovery dv/dt Waveforms

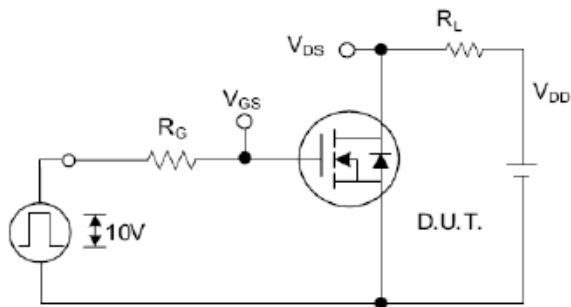

Fig. 2.1 Switching Test Circuit

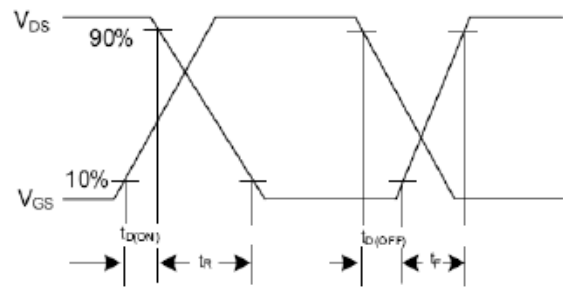

Fig. 2.2 Switching Waveforms

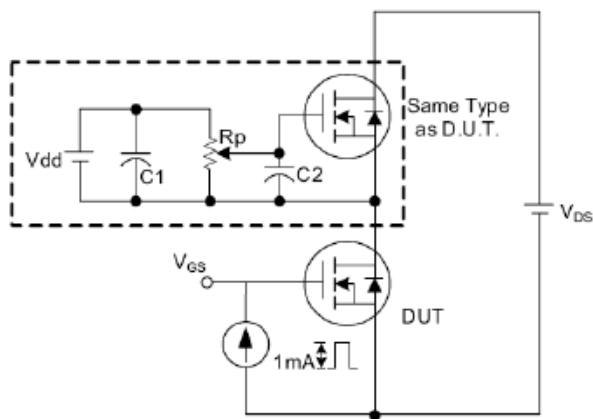

Fig. 3. 1 Gate Charge Test Circuit

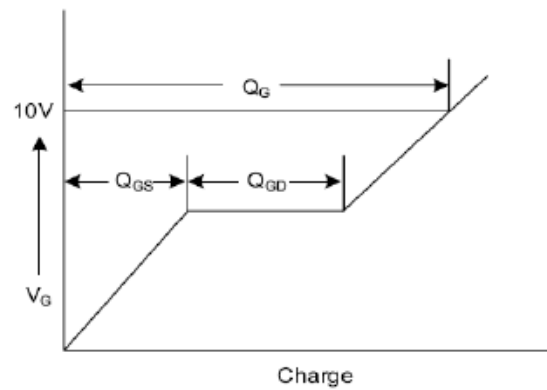

Fig. 3. 2 Gate Charge Waveform

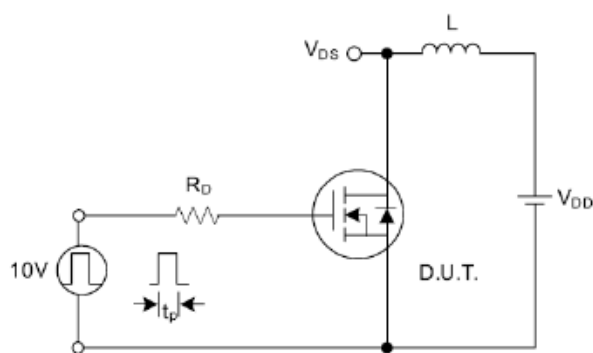

Fig. 4.1 Unclamped Inductive Switching Test Circuit

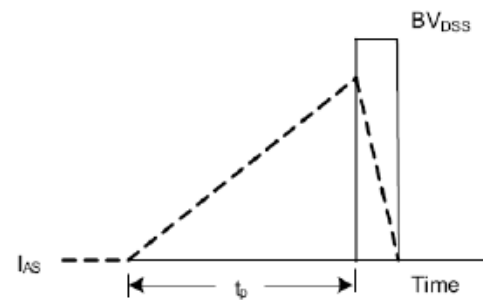

Fig. 4.2 Unclamped Inductive Switching Waveforms